

BENCHTOP CENTRIFUGES

— ROTANTA 460 | 460 R

SUPERIOR BENCHTOP FOR MULTI-PURPOSE USE

This powerful unit is capable of virtually any application you choose. It is able to spin high sample volumes of blood tubes, conical tubes, plates and bottles. Speciality buckets are able to accommodate 450 ml blood bags.

This unit is available with refrigeration and a temperature range from -20 °C to +40 °C (ROTANTA 460 R).



— HIGHLIGHTS

- RPM: 50 - 15,000 min⁻¹
Adjustable in increments of 10
- RCF: 50 - 24,400
Adjustable in increments of 1
- max. Capacity: 4 x 1,000 ml
- choice of 8 rotors
- Medical Device according to directive 93/42/EC
- 28 individual acceleration and deceleration stages
- easy operation with keypad and control knob
- 98 program memories for more individuality
- model 460 R coolable from -20 to +40 °C with pre-cooling function

— FEATURES

- metal housing and lid
- viewing port in the lid
- powered one-hand lid lock
- lid dropping protection
- emergency lid lock release
- stainless steel chamber
- automatic rotor recognition
- brushless drive
- error display
- display in °C and °F possible
- imbalance monitoring and switch-off
- backlit panel with actual values of all parameters
- auditory message after completion of the centrifugation run

TECHNICAL DATA

	ROTANTA 460 non-refrigerated	ROTANTA 460 R refrigerated
voltage *)	220 – 240 V 1 ~	220 – 240 V 1 ~
frequency	50 – 60 Hz	50 Hz
consumption	1,000 VA	1,800 VA
emission, immunity	EN/IEC 61326-1, class B	EN/IEC 61326-1, class B
max. capacity	4 x 1,000 ml	4 x 1,000 ml
max. RPM	15,000 min ⁻¹	15,000 min ⁻¹
max. RCF	24,400	24,400
running time	1 – 99 h: 59 min: 59 s, ∞ continuous run, short cycle mode	1 – 99 h: 59 min: 59 s, ∞ continuous run, short cycle mode
dimensions (WxDxH)	554x706x456 mm	770x706x456 mm
weight	approx. 101 kg	approx. 141 kg
noise level	46 dB (A) with rotor 4474	58 dB (A) with rotor 4474
temperature control, infinitely variable	-	from -20 to +40 °C
Cat. No.	5650	5660
100 – 127 V 1 ~ / 60 Hz *)	5650-01	5660-01
consumption	1,100 VA	2,000 VA
emission, immunity	FCC class B	FCC class B
weight	approx. 111 kg	approx. 151 kg

*) Other voltages on request.

AVAILABLE ROTORS

SWING-OUT ROTORS

	angle	max. RPM	max. capacity	Cat. No.	page
 swing-out rotor, 4-place	90°	4,600 min ⁻¹	4x750 ml	5699-R	3
 swing-out rotor, 4-place	90°	3,800 min ⁻¹	4x1,000 ml	5654	10
 swing-out rotor, 6-place	90°	4,000 min ⁻¹	6x290 ml	4446	12
 swing-out rotor, 4-place	90°	2,000 min ⁻¹	4x100 ml	4474	14
 swing-out rotor, 2-place	90°	5,900 min ⁻¹ / 6,200 min ⁻¹	12 plates	5622	14

ANGLE ROTORS

 angle rotor, 30-place	45°	15,000 min ⁻¹	30x2 ml	4489-A	15
 angle rotor, 6-place	25°	8,500 min ⁻¹ / 9,500 min ⁻¹	6x250 ml	5645	15
 angle rotor, 6-place	45°	11,500 min ⁻¹	6x94 ml	5615	16

SWING-OUT ROTOR, 4-PLACE | 5699-R



Rotor	
max. RPM max. RCF ²⁾	4,600 min ⁻¹ 5,063
max. capacity	4x250 ml
run-up run-down, braked in sec	79 88
angle temperature in °C ¹⁾	90° +10
Cat. No.	5699-R

Bucket	
lid bioseal ⁵⁾	5627
Cat. No.	5625-A

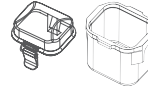

Vessels															
capacity in ml	1.5	2.0	3	4	4	5	6	7	15	25	75	94	100	100	250
Ø x L in mm	11 x 38	11 x 38	10 x 60	10 x 88	12 x 60	12 x 75	12 x 82	12 x 100	17 x 100	24 x 100	34 x 100	38 x 110	44 x 100	40 x 115	65 x 115
max. RCF ²⁾	3,572 / 4,637	3,572 / 4,637	4,637	4,637	4,637	4,637	4,637	4,637	4,637	4,637	4,495	4,495	4,637	4,495	4,495
radius in mm	151/196	151/196	196	196	196	196	196	196	196	196	190	190	196	190	190
Cat. No.	microliter tubes			tubes²⁾											

Adapter															
boring Ø x L in mm	11 x 84	11 x 84	11 x 84	11 x 84	13.5 x 84	13.5 x 84	13.5 x 84	13.5 x 84	17.5 x 84	26.5 x 84	36 x 80	42 x 80	46 x 84	42 x 80	66 x 80
vessels per rotor	224	224	120	120	80	80	80	80	68	24	12	12	8	12	4
Cat. No.	4730	4730	4730	4730	4732	4732	4732	4732	4733	4734	4735	4736	4737	4736	4738

Vessels															
capacity in ml	1.1–1.4	2.6–2.9	2.7–3	4–5.5	4.5–5	4.9	7.5–8.2	9–10	10	1.6–5	4–7	4–7	8.5–10	14	15
Ø x L in mm	8 x 66	13 x 65	11 x 66	15 x 75	11 x 92	13 x 90	15 x 92	16 x 92	15 x 102	13 x 75	13 x 100	16 x 75	16 x 100	16.5 x 106	17 x 120
max. RCF ²⁾	4,637	4,637	4,637	4,637	4,637	4,637	4,637	4,637	4,637	4,637	4,637	4,637	4,637	4,637	4,637
radius in mm	196	196	196	196	196	196	196	196	196	196	196	196	196	196	196
Cat. No.	blood collection / urine vessels												tubes with screw cap		

Adapter															
boring Ø x L in mm	11 x 84	13.5 x 84	13.5 x 84	17.5 x 84	13.5 x 84	13.5 x 84	17.5 x 84	17.5 x 84	17.5 x 84	13.5 x 84	13.5 x 84	17.5 x 84	17.5 x 84	17 x 80	17 x 80
vessels per rotor	120	80	80	68	80	80	68	68	68	80	80	68	68	48	48
Cat. No.	4730	4732	4732	4733	4732	4732	4733	4733	4733	4732	4732	4733	4733	4739⁴⁾	4739

Vessels										
capacity in ml	50	12	25	30	50	10	30	50	85	94
Ø x L in mm	30 x 115	17 x 100	25 x 90	25 x 110	29 x 115	16 x 80	26 x 95	29 x 107	38 x 106	38 x 110
max. RCF ²⁾	4,637	4,637	4,637	4,637	4,637	4,637	4,637	4,637	4,495	4,495
radius in mm	196	196	196	196	196	196	196	196	190	190
Cat. No.	tubes with screw cap									

Adapter										
boring Ø x L in mm	30 x 80	17 x 80	26.5 x 84	26.5 x 84	30 x 80	17.5 x 84	26.5 x 84	30 x 80	42 x 80	42 x 80
vessels per rotor	20	48	24	24	20	68	24	20	12	12
Cat. No.	4740	4739⁴⁾	4734	4734	4740	4733	4734	4740	4736	4736

- 1) For cooled versions: Lowest temperature achievable with precooling and max. speed.
- 2) Please note that the RCF values indicated refer only to rotor performance. The max. permissible RCF of tubes used should be verified with the individual manufacturers. The max. RCF for glass tubes annotated with footnote 2) is 4,000.
- 4) Please remove the spacer.
- 5) Tested by the TÜV in conformity with DIN EN 61010, section 2-020.

SWING-OUT ROTOR, 4-PLACE | 5699-R



Rotor	
max. RPM max. RCF ²⁾	4,600 min ⁻¹ 4,779
max. capacity	4 x 750 ml
run-up run-down, braked in sec	90 95
angle temperature in °C ¹⁾	90° +7
Cat. No.	5699-R

Bucket with clamp lock	
lid bioseal ⁵⁾	4883
Cat. No.	4880

Bucket without clamp lock¹⁴⁾	
Cat. No.	4885



Vessels															
capacity in ml	1.5	2.0	3	4	4	5	6	7	15	25	45	50	94	100	100
Ø x L in mm	11 x 38	11 x 38	10 x 60	10 x 88	12 x 60	12 x 75	12 x 82	12 x 100	17 x 100	24 x 100	31 x 100	34 x 100	38 x 110	40 x 115	44 x 100
max. RCF ²⁾	3,572 / 4,637	3,572 / 4,637	4,637	4,637	4,637	4,637	4,637	4,637	4,637	4,637	4,495	4,495	4,495	4,495	4,637
radius in mm	151/196	151/196	196	196	196	196	196	196	196	196	190	190	190	190	196
Cat. No.	microliter tubes			tubes²⁾											

Adapter																
boring Ø x L in mm	11 x 84	11 x 84	11 x 84	11 x 84	13.5 x 84	13.5 x 84	13.5 x 84	13.5 x 84	17.5 x 84	26.5 x 84	36 x 80	36 x 80	42 x 80	42 x 80	46 x 84	
vessels per rotor	192	192	96	96	76	76	76	76	76	28	16	16	12	12	8	
Cat. No.	4830	4830	4830	4830	4832	4832	4832	4832	4832	4833	4834	4835	4835	4836	4836	4837

Vessels															
capacity in ml	250	1.1–1.4	2.6–2.9	2.6–2.9	2.7–3	4–5.5	4.5–5	4.9	4.9	7.5–8.2	9–10	9–10	10	1.6–5	1.6–5
Ø x L in mm	65 x 115	8 x 66	13 x 65	13 x 65	11 x 66	15 x 75	11 x 92	13 x 90	13 x 90	15 x 92	16 x 92	16 x 92	15 x 102	13 x 75	13 x 75
max. RCF ²⁾	4,495	4,637	4,116	4,637	4,637	4,637	4,637	4,637	4,684	4,637	4,684	4,637	4,637	4,116	4,637
radius in mm	190	196	174	196	196	196	196	196	198	196	198	196	196	174	196
Cat. No.	- 2)	blood collection / urine vessels													

Adapter															
boring Ø x L in mm	66 x 80	11 x 84	13.2 x 61	13.5 x 84	13.5 x 84	17.5 x 84	13.5 x 84	13.5 x 84	13.2 x 61	17.5 x 84	17.5 x 61	17.5 x 84	17.5 x 84	13.2 x 61	13.5 x 84
vessels per rotor	4	96	108	76	76	76	76	76	108	76	88	76	76	108	76
Cat. No.	4838	4830	4847	4832	4832	4833	4832	4832	4847⁴⁾	4833	4848	4833	4833	4847	4832

Vessels														
capacity in ml	4–7	4–7	4–7	8	8.5–10	8.5–10	14	15	50	50	12	25	30	
Ø x L in mm	13 x 100	16 x 75	16 x 75	16 x 125	16 x 100	16 x 100	16.5 x 106	17 x 120	29 x 115	29 x 115	17 x 100	25 x 90	25 x 110	
max. RCF ²⁾	4,684	4,637	4,684	4,637	4,637	4,684	4,637	4,637	4,708	4,637	4,637	4,637	4,637	
radius in mm	198	196	198	196	196	198	196	196	199	196	196	196	196	
Cat. No.	blood collection / urine vessels						tubes with screw cap							

Adapter													
boring Ø x L in mm	13.2 x 61	17.5 x 84	17.5 x 61	17.5 x 84	17.5 x 84	17.5 x 61	17 x 80	17 x 80	30 x 96.5	30 x 80	17 x 80	26.5 x 84	26.5 x 84
vessels per rotor	108	76	88	76	76	88	56	56	28	28	56	28	28
Cat. No.	4847⁴⁾	4833	4848	4833	4833	4848	4839⁴⁾	4839	5647	4840	4839⁴⁾	4834	4834

SWING-OUT ROTOR, 4-PLACE | 5699-R



Rotor	
max. RPM max. RCF	4,600 min ¹⁾ 4,779
max. capacity	4 x 750 ml
run-up run-down, braked in sec	90 95
angle	90°
temperature in °C ¹⁾	+7
Cat. No.	5699-R

Bucket with clamp lock

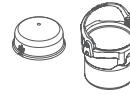

lid bioseal ⁵⁾	4883
Cat. No.	4880

Bucket without clamp lock¹⁴⁾



Cat. No.	4885
-----------------	-------------



Vessels

capacity in ml	50	50	10	10	30	50	50	85	94	250	500	600	750	450	750	
Ø x L in mm	30 x 115	29 x 115	16 x 80	16 x 80	26 x 95	29 x 107	29 x 107	38 x 106	38 x 110	61 x 122	96 x 147	93 x 134	97 x 152	97 x 110	96 x 135	
max. RCF ²⁾	4,708	4,637	4,637	4,684	4,637	4,637	4,708	4,495	4,495	4,779	4,779	4,779	4,779	4,779	4,779	
radius in mm	199	196	196	198	196	196	199	190	190	202	202	202	202	202	202	
Cat. No.	tubes with screw cap										5127²⁴⁾	Corning[®]	0551²⁴⁾	0512²⁴⁾	4447	4234-A

Adapter

boring Ø x L in mm	30 x 96.5	30 x 80	17.5 x 84	17.5 x 61	26.5 x 84	30 x 80	30 x 96.5	42 x 80	42 x 80	62 x 100	98 x 100	94 x 95	98 x 100	98 x 100	98 x 100
vessels per rotor	28	20	76	88	28	20	28	12	12	4	4	4	4	4	4
Cat. No.	5647⁴⁾	4840⁴⁾	4833	4848	4834	4840⁴⁾	5647⁴⁾	4836	4836	4841	4845	4846	4845	4845	4845

Vessels

capacity in ml	30	50	40	160	200	200	200
Ø x L in mm	-	-	-	-	-	-	-
max. RCF ²⁾	4,613 ²⁷⁾	4,613 ²⁷⁾	4,613 ²⁷⁾	4,613 ²⁷⁾	4,613 ²⁷⁾	4,613 ²⁷⁾	4,613 ²⁷⁾
radius in mm	195	195	195	195	195	195	195
Cat. No.	Falcon[®]	Corning[®]	Nunc[®]	Nunc[®]	Falcon[®]	Greiner[®]	Nunc[®]

Adapter

boring Ø x L in mm	-	-	-	-	-	-	-
vessels per rotor	8	8	4	8	4	4	4
Cat. No.	4849	4849	4852	4851	4831	4831	4831

1) For cooled versions: Lowest temperature achievable with precooling and max. speed.
 2) Please note that the RCF values indicated refer only to rotor performance. The max. permissible RCF of tubes used should be verified with the individual manufacturers. The max. RCF for glass tubes annotated with footnote 2) is 4,000.
 3.8) When using these tubes, bucket 4880 cannot be closed with lid 4883.
 3.9) When using these tubes, bucket 4890 cannot be closed with lid 4883.
 4) Please remove the spacer.
 5) Tested by the TÜV in conformity with DIN EN 61010, section 2-020.
 14) With the E3906 add-on kit and the 4783 lid, the 4885/4895 carrier can be converted at a later time to a 4780 carrier with single-hand clamp lock.
 21) Adapter must be loaded as illustrated.
 24) At temperatures of over +40 °C and / or when not filled to capacity, bottles may warp during centrifugation.
 27) RCF values indicated refer only to rotor performance. The max. RCF for the accommodated cell culture flasks is 2,300.
 28) We recommend the use of the refrigerated ROTANTA 460 R, 460 RC, or 460 RF to ensure that the temperature of the blood is maintained during centrifugation.

SWING-OUT ROTOR, 4-PLACE | 5699-R



Rotor	
max. RPM max. RCF ²⁾	4,600 min ⁻¹ 5,063
max. capacity	4 x 750 ml
run-up run-down, braked in sec	90 95
angle	90°
temperature in °C ¹⁾	+7
Cat. No.	5699-R

Bucket with clamp lock	
lid bioseal ⁵⁾	4883
Cat. No.	4890

Bucket without clamp lock¹⁴⁾	
Cat. No.	4895



Vessels																
capacity in ml		1.5	2.0	5	7	8	9	15	25	50	100	2.6-2.9	2.7-3	4-5.5	4.5-5	4.9
Ø x L in mm		11 x 38	11 x 38	12 x 75	12 x 100	16 x 81	14 x 100	17 x 100	24 x 100	34 x 100	44 x 100	13 x 65	11 x 66	15 x 75	11 x 92	13 x 90
max. RCF ²⁾	top / bottom	3,407 / 4,542	3,407 / 4,542	4,471	4,471	4,637	4,637	4,637	4,353	4,424	4,400	4,471	4,471	4,637	4,471	4,471
radius in mm	top / bottom	144 / 192	144 / 192	189	189	196	196	196	184	187	186	189	189	196	189	189
Cat. No.		microliter tubes					tubes²⁾					blood collection / urine vessels				

Adapter																
boring Ø x L in mm		11.5 x 38	11.5 x 38	13 x 58	13 x 58	17.5 x 53	17.5 x 53	17.5 x 53	26 x 72	36 x 79	45 x 78	13.5 x 58	13 x 58	17.5 x 53	13 x 58	13.5 x 58
vessels per rotor		168	168	120	120	76	76	76	28	16	8	84	120	76	120	84
Cat. No.		4432	4432	4433	4433	4434	4434	4434	4438	4439	4442	4435	4433	4434	4433	4435

Vessels																
capacity in ml		7.5-8.2	9-10	10	1.6-5	4-7	4-7	8	8.5-10	10	15	50	25	30	50	50
Ø x L in mm		15 x 92	16 x 92	15 x 102	13 x 75	13 x 100	16 x 75	16 x 81	16 x 100	16 x 80	17 x 120	29 x 115	25 x 90	25 x 110	29 x 115	29 x 107
max. RCF ²⁾		4,637	4,637	4,637	4,471	4,471	4,637	4,637	4,637	4,637	4,755	4,613	4,566	4,566	4,613	4,613
radius in mm		196	196	196	189	189	196	196	196	196	201	195	193	193	195	195
Cat. No.		blood collection / urine vessels								tubes with screw cap						

Adapter																
boring Ø x L in mm		17.5 x 60	17.5 x 60	17.5 x 60	13.5 x 58	13.5 x 58	17.5 x 60	17.5 x 60	17.5 x 60	17.5 x 60	17 x 102	31 x 96	26 x 72	26 x 72	31 x 96	31 x 96
vessels per rotor		76	76	76	84	84	76	76	76	76	56	28	28	28	28	28
Cat. No.		4434	4434	4434	4435	4435	4434	4434	4434	4434	4469	4468	4438	4438	4468⁴⁾	4468

Vessels															
capacity in ml		250	290	600	750	175	175	200	225	250	500	450	750	450	
Ø x L in mm		61 x 122	62 x 137	93 x 134	97 x 152	61 x 118	62 x 144	60 x 130	61 x 137	60 x 172	96 x 147	97 x 110	96 x 135	3-place-system without filter	
max. RCF ²⁾		4,873	4,873	4,873	4,873	5,063	5,063	5,063	5,063	5,063	5,063	5,063	5,063	5,063	
radius in mm		206	206	206	206	214	214	214	214	214	214	214	214	214	
Cat. No.		5127²⁴⁾	-²⁴⁾	0551²⁴⁾	0512²⁴⁾	Falcon®	Nalgene®	Nunc®	Falcon®	Coming®	Coming®	4447	4234-A	blood bags²⁸⁾	

Adapter														
boring Ø x L in mm		62 x 92	62 x 92	98.4 x 116	98.4 x 116	61 x 105	61 x 105	61 x 105	61 x 105	61 x 105	-	98.4 x 116	98.4 x 116	-
vessels per rotor		4	4	4	4	4	4	4	4	4	4	4	4	4
Cat. No.		4443	4443	4451	4451	4440	4430	4430	4440	4430	4449	4451	4451	-

— SWING-OUT ROTOR, 4-PLACE | 5699-R



Rotor

max. RPM max. RCF ²⁾	4,600 min ⁻¹ 4,637
max. capacity	4 x 450 ml
run-up run-down, braked in sec	90 95
angle temperature in °C ¹⁾	90° +10
Cat. No.	5699-R



Bucket

Cat. No.	5691-A
----------	--------



holder for systems without filter holder for systems with and without filter



Blood bags

capacity in ml	450	450
blood bag	3-place-System	4-place-System
max. RCF ²⁾	4,637	4,637
radius in mm	196	196
Cat. No.	5693	5695



Insert

boring Ø x L in mm	-	-
blood bags per rotor	4	4
Cat. No.	5692	5692

— SWING-OUT ROTOR, 4-PLACE | 5699-R



Rotor

max. RPM max. RCF ²⁾	4,600 min ⁻¹ 4,921
max. capacity	12 Arrays
run-up run-down, braked in sec	90 95
angle temperature in °C ¹⁾	90° +10
Cat. No.	5699-R



Bucket

Cat. No.	5636
----------	------

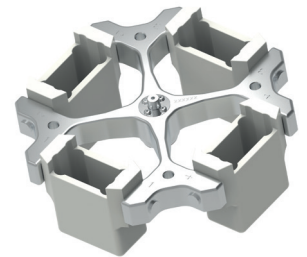

TagMan Array

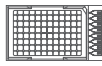

Array

capacity in ml	-
W x D x H in mm	152.5x85.5x12
max. RCF ²⁾	4,921
radius in mm	208
Cat. No.	-



Adapter

boring Ø x L in mm	-
arrays per rotor	12
Cat. No.	5648

- 1) For cooled versions: Lowest temperature achievable with precooling and max. speed.
- 2) Please note that the RCF values indicated refer only to rotor performance. The max. permissible RCF of tubes used should be verified with the individual manufacturers. The max. RCF for glass tubes annotated with footnote 2) is 4,000.

SWING-OUT ROTOR, 4-PLACE | 5699-R



Rotor

max. RPM max. RCF ²⁾	4,600 min ⁻¹ 4,258
max. capacity	4 x 250 ml
run-up run-down, braked in sec	90 95
angle temperature in °C ¹⁾	90° +10
Cat. No.	5699-R

+

Bucket



Cat. No. **5628⁹⁾**



Adapter

Cat. No. **5220-A**

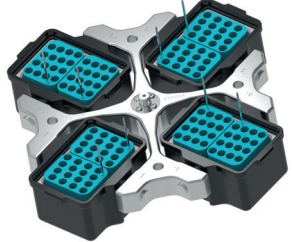

Vessels	1.5		2.0		3		5		6		7		9		25		50		100		100		250		1.1-1.4		2.6-2.9		2.7-3	
	capacity in ml	11 x 38	11 x 38	10 x 60	12 x 75	12 x 82	12 x 100	14 x 100	24 x 100	34 x 100	44 x 100	40 x 115	65 x 115	8 x 66	13 x 65	11 x 66														
max. RCF ²⁾	4,164	4,164	4,069	4,164	4,164	4,164	4,116	4,093	4,093	4,069	4,069	4,045	4,069	4,164	4,116															
radius in mm	176	176	172	176	176	176	174	173	173	172	172	171	172	176	174															
Cat. No.	microliter tubes												tubes²⁾										blood collection / urine vessels							
	+ 5220-A	+ 5220-A	+ 5220-A	+ 5220-A	+ 5220-A	+ 5220-A	+ 5220-A	+ 5220-A	+ 5220-A	+ 5220-A	+ 5220-A	+ 5220-A	+ 5220-A	+ 5220-A	+ 5220-A	+ 5220-A	+ 5220-A	+ 5220-A	+ 5220-A	+ 5220-A	+ 5220-A	+ 5220-A	+ 5220-A	+ 5220-A	+ 5220-A	+ 5220-A	+ 5220-A	+ 5220-A		
Adapter																														
boring Ø x L in mm	11.5 x 50	11.5 x 50	11 x 44	13.5 x 52	13.5 x 52	13.5 x 52	16 x 50	26 x 82.5	36 x 82.5	45.5 x 82	42 x 82	66 x 81	11 x 44	13.5 x 52	12.5 x 39.5															
vessels per rotor	128	128	160	96	96	96	96	40	16	8	8	4	160	96	160															
Cat. No.¹⁹⁾	5281	5281	5267	5268	5268	5268	5264	5242	5243	5262	5249	5263-A	5267	5268	5227															

Vessels	4-5.5		4.5-5		4.9		7.5-8.2		9-10		1.6-5		4-7		4-7		8.5-10		15		30		50		50		250	
	capacity in ml	15 x 75	11 x 92	13 x 90	15 x 92	16 x 92	13 x 75	16 x 75	13 x 100	16 x 100	17 x 120	25 x 110	29 x 115	29 x 115	65 x 115													
max. RCF ²⁾	4,116	4,116	4,164	4,116	4,093	4,164	4,116	4,164	4,093	4,258	4,187	4,258	4,187	4,045														
radius in mm	174	174	176	174	173	176	174	176	173	180	177	180	177	171														
Cat. No.	blood collection / urine vessels												tubes with screw cap						5127²⁴⁾									
	+ 5220-A	+ 5220-A	+ 5220-A	+ 5220-A	+ 5220-A	+ 5220-A	+ 5220-A	+ 5220-A	+ 5220-A	+ 5220-A	+ 5220-A	+ 5220-A	+ 5220-A	+ 5220-A	+ 5220-A	+ 5220-A	+ 5220-A	+ 5220-A	+ 5220-A	+ 5220-A	+ 5220-A	+ 5220-A	+ 5220-A	+ 5220-A	+ 5220-A	+ 5220-A	+ 5220-A	+ 5220-A
Adapter																												
boring Ø x L in mm	16 x 50	12.5 x 42	13.5 x 52	16 x 50	17.6 x 82.5	13.5 x 52	16 x 50	13.5 x 52	17.7 x 86	17 x 90	26 x 82.5	30 x 85	30 x 82	66 x 81														
vessels per rotor	96	160	96	96	88	96	96	96	88	56	40	24	24	4														
Cat. No.¹⁹⁾	5264	5227	5268	5264	5258	5268	5264	5268	5258	6337-B	5266⁴⁾	6338-B	6339-A	5263-A⁴⁾														

Vessels

capacity in ml	1-8
Ø x L in mm	simple / multiple
max. RCF ²⁾	2,744 / 4,069
radius in mm	116 / 172
Cat. No.	cyto chambers



Adapter

boring Ø x L in mm	-
vessels per rotor	16
Cat. No.¹⁹⁾	5280



CYTO Cyto system available for this model. More information on [page 180](#)

- 1) For cooled versions: Lowest temperature achievable with precooling and max. speed.
- 2) Please note that the RCF values indicated refer only to rotor performance. The max. permissible RCF of tubes used should be verified with the individual manufacturers. The max. RCF for glass tubes annotated with footnote 2) is 4,000.
- 4) Please remove the spacer.
- 9) Max. permissible loading weight of carrier 5628: 800 g. The loading weight is the sum of the weight of the respective adapters, frames, the tubes and their contents.
- 19) Two adapters can be placed on each bucket.
- 24) At temperatures of over +40 °C and / or when not filled to capacity, bottles may warp during centrifugation.

SWING-OUT ROTOR, 4-PLACE | 5699-R









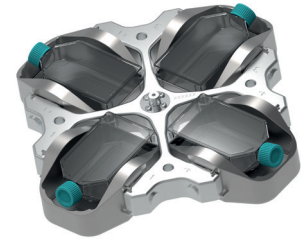



Rotor	
max. RPM max. RCF	4,600 min ⁻¹ 3,785
max. capacity	4 x 200 ml
run-up run-down, braked in sec	90 95
angle temperature in °C ¹⁾	90° +10
Cat. No.	5699-R



Bucket	
Cat. No.	5630-B



Vessels						
capacity in ml		40	160	250/260	250/260	250/260
Ø x L in mm		-	-	-	-	-
max. RCF ²⁾		3,785 ²⁾	3,785 ²⁾	3,785 ²⁾	3,785 ²⁾	3,785 ²⁾
radius in mm		180	160	160	160	160
Cat. No.		Nunc®	Nunc®	Falcon®	Greiner®	Nunc®

Adapter						
boring Ø x L in mm		-	-	-	-	-
vessels per rotor		4	4	4	4	4
Cat. No.		5672	5673	5671	5671	5671

Accommodated cell culture flask:

40 ml
Nunc®, No. 156340 or 156367

160 ml
Nunc®, No. 156472 or 156499
Sarstedt®, No. 83.3911.xxx

200 ml
Becton Dickinson®, No. 353024
Greiner®, No. 658170
Nunc®, No. 153732 or 147589

SWING-OUT ROTOR, 4-PLACE | 5699-R





















Rotor	
max. RPM max. RCF	4,600 min ⁻¹ 3,832
max. capacity	24 plates
run-up run-down, braked in sec	79 88
angle temperature in °C ¹⁾	90° +10
Cat. No.	5699-R



Bucket	
Cat. No.	5630-B



Plates										
W x D x H in mm		128x86x15	128x86x17.5	128x86x22	128x86x44.5	128x86x46	128x86x83	84x59x11	124x82x20	-
capacity in ml		-	-	-	-	-	-	-	-	0.2
max. RCF ²⁾		3,832	3,832	3,832	3,832	3,832	3,832	3,832	3,832	3,832
radius in mm		max. 162	max. 162	max. 162	max. 162	max. 162	max. 162	max. 162	max. 162	max. 162
Cat. No.		MTP	MTP	CP	DWP	MS	QP	Microtest plate	PCR plate	PCR strips

Removal frame										
boring Ø x L in mm		-	-	-	-	-	-	-	-	-
plates / strips per rotor		24	20	16	4	4	4	8	4	48 x 8
Cat. No.		4626	4626	4626	4626	4626	4626	4626	4626 + 1485	4626 + 1485

1) For cooled versions: Lowest temperature achievable with precooling and max. speed.
 2) Please note that the RCF values indicated refer only to rotor performance. The max. permissible RCF of tubes used should be verified with the individual manufacturers. The max. RCF for glass tubes annotated with footnote 2) is 4,000.
 27) RCF values indicated refer only to rotor performance. The max. RCF for the accommodated cell culture flasks is 2,300.







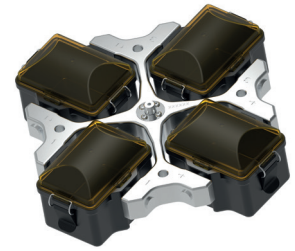

SWING-OUT ROTOR, 4-PLACE | 5699-R

	
Rotor	
max. RPM max. RCF	4,600 min ⁻¹ 4,211
max. capacity	24 plates
run-up run-down, braked in sec	79 88
angle temperature in °C ¹⁾	90° +10
Cat. No.	5699-R











	
Bucket	
lid bioseal ⁵⁾	5629
Cat. No.	5628⁹⁾



Plates									
W x D x H in mm	128x86x15	128x86x17.5	128x86x22	128x86x44.5	128x86x46	128x86x83	84x59x11	124x82x20	-
capacity in ml	-	-	-	-	-	-	-	-	0.2
max. RCF ²⁾	4,211	4,211	4,211	4,211	4,211	4,211	4,211	4,211	4,211
radius in mm	max. 178	max. 178	max. 178	max. 178	max. 178	max. 178	max. 178	max. 178	max. 178
Cat. No.	MTP	MTP	CP	DWP	MS	QP	Microtest plate	PCR plate	PCR strips



Removal frame									
boring Ø x L in mm	-	-	-	-	-	-	-	-	-
plates / strips per rotor	24	20	16	4	4	4	8	4	48 x 8
Cat. No.	4626	4626	4626	4626	4626	4626	4626	4626 + 1485	4626 + 1485







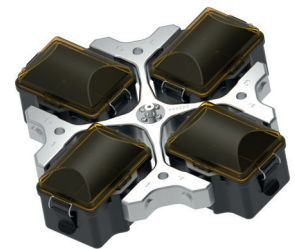

SWING-OUT ROTOR, 4-PLACE | 5654

	
Rotor	
max. RPM max. RCF	3,800 min ⁻¹ 2,890
max. capacity	24 plates
run-up run-down, braked in sec	62 58
angle max. noise level	90° 57 dB (A)
temperature in °C ¹⁾	-4
Cat. No.	5654











	
Bucket	
lid bioseal ⁵⁾	5629
Cat. No.	5653



Plates									
W x D x H in mm	128x86x15	128x86x17.5	128x86x22	128x86x44.5	128x86x46	128x86x83	84x59x11	124x82x20	-
capacity in ml	-	-	-	-	-	-	-	-	0.2
max. RCF ²⁾	2,890	2,890	2,890	2,890	2,890	2,890	2,890	2,890	2,890
radius in mm	max. 179	max. 179	max. 179	max. 179	max. 179	max. 179	max. 179	max. 179	max. 179
Cat. No.	MTP	MTP	CP	DWP	MS	QP	Microtest plate	PCR plate	PCR strips



Removal frame									
boring Ø x L in mm	-	-	-	-	-	-	-	-	-
plates / strips per rotor	24	20	16	4	4	4	8	4	48 x 8
Cat. No.	4626	4626	4626	4626	4626	4626	4626	4626 + 1485	4626 + 1485

1) For cooled versions: Lowest temperature achievable with precooling and max. speed.
 2) Please note that the RCF values indicated refer only to rotor performance. The max. permissible RCF of tubes used should be verified with the individual manufacturers. The max. RCF for glass tubes annotated with footnote 2) is 4,000.
 5) Tested by TÜV in conformity with DIN EN 61010, section 2-020.
 9) Max. permissible loading weight of carrier 5628: 800 g. The loading weight is the sum of the weight of the respective adapters, frames, the tubes and their contents.

SWING-OUT ROTOR, 4-PLACE | 5654



Rotor	
max. RPM max. RCF	3,800 min ⁻¹ 3,196
max. capacity	4 x 1,000 ml
run-up run-down, braked in sec	62 58
angle max. noise level	90° 58 dB (A)
temperature in °C ¹⁾	+3
Cat. No.	5654

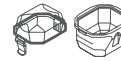

Bucket	
lid bioseal ⁵⁾	5652
Cat. No.	5651-A



Vessels																
capacity in ml		3	4	4	5	6	7	10	10	15	1.1–1.4	2.6–3.4	2.7–3	4.5–5	4–5.5	4.9
Ø x L in mm		10 x 60	10 x 88	12 x 60	12 x 75	12 x 82	12 x 100	13 x 100	13 x 100	17 x 100	8 x 66	13 x 65	11 x 66	11 x 92	15 x 75	13 x 90
max. RCF ²⁾		2,874	2,874	2,874	2,874	2,874	2,874	2,906	2,906	2,970	2,874	2,906	2,874	2,874	2,970	2,906
radius in mm		178	178	178	178	178	178	180	180	184	178	180	178	178	184	180
Cat. No.		tubes²⁾									blood collection / urine vessels					

Adapter																
boring Ø x L in mm		12.5 x 40	12.5 x 40	12.5 x 40	12.5 x 40	12.5 x 40	12.5 x 40	13.2 x 42.4	13.2 x 42.4	17.2 x 46.5	12.5 x 40	13.2 x 42.4	12.5 x 40	12.5 x 40	17.2 x 46.5	13.2 x 42.4
vessels per rotor		292	292	292	292	292	292	196	188	148	292	196	292	292	148	196
Cat. No.		5684	5684	5684	5684	5684	5684	5674	5685	5682	5684	5674	5684	5684	5682	5674

Vessels																
capacity in ml		7.5–8.2	9–10	10	1.6–5	4–7	4–7	4–7	8.5–10	10	15	50	175	175	200	225
Ø x L in mm		15 x 92	16 x 92	15 x 102	13 x 75	16 x 75	13 x 100	13 x 100	16 x 100	16 x 80	17 x 120	29 x 115	61 x 118	62 x 144	60 x 130	61 x 137
max. RCF ²⁾		2,970	2,970	2,970	2,906	2,970	2,906	2,906	2,970	2,970	3,196	3,196	3,196	3,196	3,196	3,196
radius in mm		184	184	184	180	184	180	180	184	184	198	198	198	198	198	198
Cat. No.		blood collection / urine vessels									tubes with screw cap		Falcon®	Nalgene®	Nunc®	Falcon®

Adapter																
boring Ø x L in mm		17.2 x 46.5	17.2 x 46.5	17.2 x 46.5	13.2 x 42.4	17.2 x 46.5	13.2 x 42.4	13.2 x 42.4	17.2 x 46.5	17.2 x 46.5	17 x 60	30 x 60	62 x 100	62 x 100	62 x 100	62 x 100
vessels per rotor		148	148	148	196	148	196	188	148	148	96	40	8	8	8	8
Cat. No.		5682	5682	5682	5674	5682	5674	5685	5682	5682	5683	5686	5681	5681	5681	5681

Vessels								
capacity in ml		250	290	450	500	600	750	1,000
Ø x L in mm		62 x 122	62 x 137	97 x 110	96 x 147	93 x 134	97 x 152	99/126 x 140
max. RCF ²⁾		3,196	3,196	3,196	3,196	3,196	3,196	3,196
radius in mm		198	198	198	198	198	198	198
Cat. No.		5127²⁴⁾	-²⁴⁾	4447	Corning®	0551²⁴⁾	0512²⁴⁾	-

Adapter								
boring Ø x L in mm		62 x 100	62 x 100	98 x 100	98 x 100	98 x 100	98 x 100	100/127 x 68
vessels per rotor		8	8	4	4	4	4	4
Cat. No.		5681	5681	5687	5687	5687	5687	5669

- 1) For cooled versions: Lowest temperature achievable with precooling and max. speed.
- 2) Please note that the RCF values indicated refer only to rotor performance. The max. permissible RCF of tubes used should be verified with the individual manufacturers. The max. RCF for glass tubes annotated with footnote 2) is 4,000.
- 3.10) When using this tubes, bucket 5651-A cannot be closed with lid 5652.
- 5) Tested by TÜV in conformity with DIN EN 61010, section 2-020.
- 24) At temperatures of over +40 °C and / or when not filled to capacity, bottles may warp during centrifugation.

SWING-OUT ROTOR, 6-PLACE | 4446



Rotor	
max. RPM max. RCF	4,000 min ⁻¹ 3,631
max. capacity	6 x 100 ml
run-up run-down, braked in sec	45 55
angle max. noise level	90° 58 dB (A)
temperature in °C ¹⁾	-3
Cat. No.	4446

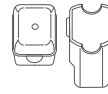

Bucket	
lid	5053
Cat. No.	5051



Vessels															
capacity in ml		1.5	2	1.5	2	3	5	6	7	9	15	25	50	100	100
Ø x L in mm		11 x 38	11 x 38	11 x 38	11 x 38	10 x 60	12 x 75	12 x 82	12 x 100	14 x 100	17 x 100	24 x 100	34 x 100	44 x 100	40 x 115
max. RCF ²⁾	top / bottom	2,486 / 3,363	2,486 / 3,363	3,363	3,363	3,274	3,309	3,309	3,291	3,309	3,291	3,291	3,291	3,291	3,291
radius in mm	top / bottom	139 / 188	139 / 188	188	188	183	185	185	184	185	184	184	184	184	184
Cat. No.		microliter tubes				tubes²⁾									

Adapter															
boring Ø x L in mm		12.5 x 37	12.5 x 37	11.5 x 50	11.5 x 50	11 x 44	12.5 x 37	12.5 x 37	12.5 x 82.5	16 x 50	17.5 x 86	26 x 86	36 x 86	45.5 x 86	42 x 86
vessels per rotor		240	240	96	96	120	120	120	120	72	72	30	12	6	6
Cat. No.		5257	5257	5281	5281	5267	5227	5227	5247¹⁵⁾	5264	5248¹⁵⁾	5242	5243	5262	5249

Vessels															
capacity in ml		1.1–1.4	2.6–2.9	2.7–3	4–5.5	4.5–5	4.9	7.5–8.2	9–10	10	1.6–5	4–7	4–7	8.5–10	
Ø x L in mm		8 x 66	13 x 65	11 x 66	15 x 75	11 x 92	13 x 90	15 x 92	16 x 92	15 x 102	13 x 75	13 x 100	16 x 75	16 x 100	
max. RCF ²⁾		3,274	3,345	3,309	3,309	3,309	3,345	3,309	3,291	3,291	3,345	3,345	3,309	3,291	
radius in mm		183	187	185	185	185	187	185	184	184	187	187	185	184	
Cat. No.		blood collection / urine vessels													

Adapter															
boring Ø x L in mm		11 x 44	13.5 x 52	12.5 x 42	16 x 50	12.5 x 42	13.5 x 52	16 x 50	17.6 x 86	17.6 x 86	13.5 x 52	13.5 x 52	16 x 50	17.5 x 86	
vessels per rotor		120	72	120	72	120	72	72	66	66	72	72	72	72	
Cat. No.		5267	5268	5227	5264	5227	5268	5264	5258	5258	5268	5268	5264	5248	

Vessels						
capacity in ml		15	50	12	50	1–8
Ø x L in mm		17 x 120	30 x 115	17 x 100	29 x 115	simple / multiple
max. RCF ²⁾	top / bottom	3,434	3,291	3,434	3,291	2,290 / 3,291
radius in mm	top / bottom	192	188	192	184	128 / 184
Cat. No.		tubes with screw cap				cyto chambers

Adapter						
boring Ø x L in mm		17 x 90	30 x 86	17 x 90	36 x 86	-
vessels per rotor		42	12	42	12	12
Cat. No.		6306	5259	6306	5243	5280

CYTO Cyto system available for this model. More information on [page 180](#)

- 1) For cooled versions: Lowest temperature achievable with precooling and max. speed.
- 2) Please note that the RCF values indicated refer only to rotor performance. The max. permissible RCF of tubes used should be verified with the individual manufacturers. The max. RCF for glass tubes annotated with footnote 2) is 4,000.
- 3.11) When using these tubes, bucket 5051 cannot be closed with lid 5053.
- 15) With Cat. No. 5247-91 or 5248-91 these adapters can also be ordered with a decanting aid.

SWING-OUT ROTOR, 6-PLACE | 4446



Rotor	
max. RPM max. RCF	4,000 min ⁻¹ 3,631
max. capacity	6 x 290 ml
run-up run-down, braked in sec	38 46
angle temperature in °C ¹⁾	90° -3
Cat. No.	4446

Bucket	
lid bioseal ⁵⁾	5093
Cat. No.	5092

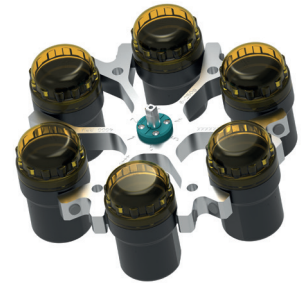

Vessels															
capacity in ml	5	6	7	15	25	50	100	100	250	1.1-1.4	1.1-1.4	2.6-2.9	2.6-2.9	2.7-3	2.7-3
Ø x L in mm	12x75	12x82	12x100	17x100	24x100	34x100	44x100	40x115	65x115	8 x 66	8 x 66	13 x 65	13 x 65	11x66	11x66
max. RCF ²⁾	3,542	3,542	3,542	3,488	3,434	3,631	3,488	3,488	3,631	3,488	3,077	3,488	3,077	3,488	3,077
radius in mm	198	198	198	195	192	195	195	195	203	195	172	195	172	195	172
Cat. No.	tubes²⁾									blood collection tubes / urine tubes					

Adapter															
boring Ø x L in mm	12.8x42	12.8x42	12.8x79.5	17.5x56.7	25.5x74	35.5x77.5	45.5x76.5	42x76.5	66x103	13.5x56.7	12.8x54.5	13.5x56.7	12.8x54.5	13.5x56.7	12.8x54.5
vessels per rotor	72	72	72	48	24	6	6	6	6	48	72	48	72	48	72
Cat. No.	5128	5128	5120	5136	5122	5124	5125	5126	1791	5137	5138	5137	5138	5137	5138

Vessels															
capacity in ml	4.9	4-4.5	4.5-5	7.5-8.2	9-10	10	1.6-5	1.6-5	4-7	4-7	8	8.5-10	10	15	30
Ø x L in mm	13x90	15x75	11x92	15x92	16x92	15x102	13x75	13x75	16x75	13x100	16x125	16x100	16x80	17x120	25 x 110
max. RCF ²⁾	3,488	3,488	3,542	3,488	3,488	3,488	3,488	3,077	3,488	3,542	3,542	3,488	3,488	3,631	3,327
radius in mm	195	195	198	195	195	195	195	172	195	198	198	195	195	203	192
Cat. No.	blood collection tubes / urine tubes											tubes with screw cap			

Adapter															
boring Ø x L in mm	13.5x56.7	17.5x56.7	12.8x79.5	17.5x56.7	17.5x56.7	17.5x56.7	13.5x56.7	12.8x54.5	17.5x56.7	12.8x79.5	17.5x79.5	17.5x56.7	17.5x56.7	17x85	25.5 x 74
vessels per rotor	48	48	72	48	48	48	48	72	48	72	42	48	48	42	24
Cat. No.	5137	5136	5120	5136	5136	5136	5137	5138	5136	5120	5121	5136	5136	5129	5122

Vessels							
capacity in ml	50	50	12	25	30	250	290
Ø x L in mm	30x115	29x115	17x100	25x90	25x110	62 x 122	62 x 137
max. RCF ²⁾	3,631	3,560	3,542	3,363	3,327	3,631	3,631
radius in mm	203	199	198	188	192	203	203
Cat. No.	tubes with screw cap					5127²⁴⁾	-²⁴⁾

Adapter							
boring Ø x L in mm	30x85	30x99	17.5x79.5	26x73	25.5x74	62x90	62x90
vessels per rotor	12	12	42	18	24	6	6
Cat. No.	5123	5135	5121	5134	5122	6319	6319

1) For cooled versions: Lowest temperature achievable with precooling and max. speed.
 2) Please note that the RCF values indicated refer only to rotor performance. The max. permissible RCF of tubes used should be verified with the individual manufacturers. The max. RCF for glass tubes annotated with footnote 2) is 4,000.
 3.5) When using these tubes, bucket 5092 cannot be closed with lid 5053.
 5) Tested by the TÜV in conformity with DIN EN 61010, section 2-020.
 24) At temperatures of over +40 °C and / or when not filled to capacity, bottles may warp during centrifugation.

SWING-OUT ROTOR, 2-PLACE | 5622

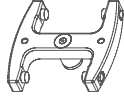

Rotor	
max. RPM ROTANTA 460 460 R	5,900 min ⁻¹ 6,200 min ⁻¹
max. RCF	5,838 6,446
max. capacity	12 plates
run-up run-down, braked in sec	50 / 52 32 / 39
angle temperature in °C ¹⁾	90° +10
Cat. No.	5622



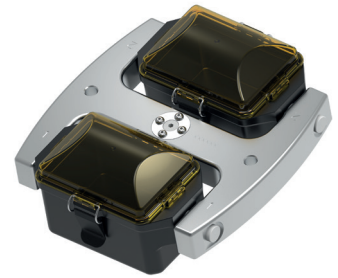

Bucket	
lid bioseal ⁵⁾	4627
Cat. No.	5631



Plates									
W x D x H in mm	128x86x15	128x86x17.5	128x86x22	128x86x44.5	128x86x46	128x86x83	84x59x11	124x82x20	-
capacity in ml	-	-	-	-	-	-	-	-	0.2
max. RCF ²⁾ ROTANTA 460 460 R	5,838 6,446	5,838 6,446	5,838 6,446	5,838 6,446	5,838 6,446	5,838 6,446	5,838 6,446	5,838 6,446	5,838 6,446
radius in mm	150	150	150	150	150	150	150	150	150
Cat. No.	MTP	MTP	CP	DWP	MS	QP	Microtest plate	PCR plate 96 wells	PCR strips
+									
Removal frame									
boring Ø x L in mm	-	-	-	-	-	-	-	-	-
vessels per rotor	12	10	8	2	2	2	4	2	24
Cat. No.	4626	4626	4626	4626	4626	4626	4626	4626 + 1485	4626 + 1485

SWING-OUT ROTOR, 4-PLACE | 4474



Rotor	
max. RPM max. RCF	2,000 min ⁻¹ 984
max. capacity	4x100 ml
run-up run-down, braked in sec	14 17
angle max. noise level	90° 46 dB (A)
temperature in °C ¹⁾	-8
Cat. No.	4474



Bucket	
Cat. No.	4275

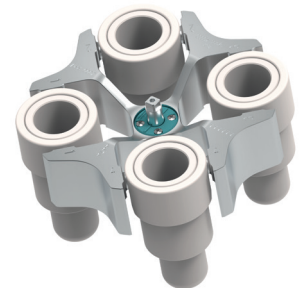

Vessels				
capacity in ml	100	100	100	50
Ø x L in mm	58x161	44x168	37x200	36.5x185
max. RCF ²⁾	984	961	961	912
radius in mm	220	215	215	204
Cat. No.	ASTM 0528^{2.1)}	ASTM^{2.1)}	ASTM 0531^{2.1)}	Babcock
+				
Adapter				
boring Ø x L in mm	-	-	-	-
vessels per rotor	4	4	4	4
Cat. No.	0771	4277	4276-B	0703-A

- 1) For cooled versions: Lowest temperature achievable with precooling and max. speed.
- 2.1) Please note that the RCF values indicated refer only to rotor performance. The max. permissible RCF of vessels used should be verified with the individual manufacturers. The max. RCF for ASTM Tubes annotated with footnote 2) is 700.
- 5) Tested by the TÜV in conformity with DIN EN 61010, section 2-020.

— ANGLE ROTOR, 30-PLACE | 4489-A



Rotor

max. RPM max. RCF	15,000 min ⁻¹ 24,400
max. capacity	30 x 2 ml
run-up run-down, braked in sec	65 63
angle temperature in °C ¹⁾	45° +4
Cat. No.	4489-A



Lid bioseal[®]
and phenol-resistant

Cat. No.

INCLUSIVE



Vessels

capacity in ml	0.2	0.4	0.5	0.8	1.5	2	0.5
Ø x L in mm	6x18	6x45	8x30	8x45	11x38	11x38	10.7x46
max. RCF ²⁾	24,400	24,400	24,400	24,400	24,400	24,400	23,394
radius in mm	97	97	97	97	97	97	93
Cat. No.	microliter tubes						Pediatric



Adapter

boring Ø x L in mm	6x40	6x40	8x40	8x40	10.2x19.3	11.2x40.1	11.2x40.1
vessels per rotor	30	30	30	30	30	30	15
Cat. No.	2024	2024	2023	2023	2031⁷⁾	-	0788



— ANGLE ROTOR, 6-PLACE | 5645



Rotor

max. RPM	ROTANTA 460 460 R	8,500 min ⁻¹ 9,500 min ⁻¹
max. RCF		11,228 14,025
max. capacity		6 x 250 ml
run-up run-down, braked in sec		98 / 115 105 / 120
angle temperature in °C ¹⁾		25° +7
Cat. No.		5645



Lid bioseal[®]
Cat. No.

INCLUSIVE



Vessels

capacity in ml	15	25	94	15	50	10	30	50	85	94	250	
Ø x L in mm	17x100	24x100	38x110	17x120	29x115	16x80	26x95	29x107	38 x 106	38 x 110	61.5x122	
max. RCF ²⁾	ROTANTA 460	10,662	10,339	9,855	10,824	9,693	10,743	10,339	9,693	9,855	9,855	11,228
max. RCF ²⁾	ROTANTA 460 R	13,319	12,915	12,310	13,521	12,108	13,420	12,915	12,108	12,310	12,310	14,025
radius in mm		132	128	122	134	118	133	128	120	122	122	139
Cat. No.		tubes²⁾			tubes with screw cap						5127²⁴⁾	



Adapter

boring Ø x L in mm	17.6 x 83	26 x 80	38.6 x 88	17 x 106	30 x 100	16.6 x 70	26 x 80	29 x 90	38.6 x 88	38.6 x 88	61.5 x 109
vessels per rotor	42	18	6	30	6	48	18	6	6	6	6
Cat. No.	5646	5642	5644	5637	5638	5641	5642	5643	5644	5644	-

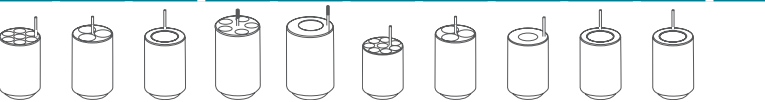

— ANGLE ROTOR, 6-PLACE | 5615



Rotor

max. RPM max. RCF	11,500 min ⁻¹ 18,038
max. capacity	6x94 ml
run-up run-down, braked in sec	58 64
angle temperature in °C ¹⁾	45° +6
Cat. No.	5615















+





















Lid bioseal⁵⁾



Cat. No.	INCLUSIVE
-----------------	------------------



Vessels															
capacity in ml	0.5	1.5	2.0	3	15	25	50	94	7.5 – 8.2	9 – 10	10	8.5 – 10	5	15	50
Ø x L in mm	10.7x46	11x38	11x38	10x60	17x100	24x100	34x100	38x110	15x92	16x92	15x102	16x100	17x51	17x120	29x115
max. RCF ²⁾	17,299	17,299	17,299	17,299	17,003	16,560	17,743	18,038	17,003	17,003	17,003	17,003	16,856	17,299	17,595
radius in mm	117	117	117	117	115	112	120	122	115	115	115	115	114	117	119
Cat. No.	Pediatric	microliter tubes			tubes²⁾				blood collection / urine tubes				-	tubes with screw cap	

Adapter															
boring Ø x L in mm	11.4x39	11.4x39	11.4x39	11.4x39	17.5x92	26x85	35x89	38.2x89.6	17.5x92	17.5x92	17.5x92	17.5x92	17x51	17x106	29.8x97
vessels per rotor	24	24	24	24	6	6	6	6	6	6	6	6	6	6	6
Cat. No.	1449	1449	1449	1449	1451	1447	1463	-	1451	1451	1451	1451	1476	1466	1454

Vessels				
capacity in ml	10	30	50	85
Ø x L in mm	16x80	26x95	29x107	38 x 106
max. RCF ²⁾	17,003	16,560	17,299	18,038
radius in mm	115	112	117	122
Cat. No.	tubes with screw cap			

Adapter				
boring Ø x L in mm	16.5x74	26x85	29x92	38.2x89.6
vessels per rotor	12	6	6	6
Cat. No.	1448	1447	1446	-

- 1) For cooled versions: Lowest temperature achievable with precooling and max. speed.
- 2) Please note that the RCF values indicated refer only to rotor performance. The max. permissible RCF of tubes used should be verified with the individual manufacturers.
The max. RCF for glass tubes annotated with footnote 2) is 4,000.
- 5) Tested by the TÜV in conformity with DIN EN 61010, section 2-020.
- 7) For centrifugation at high speeds, we recommend to use form-fitting, phenol-resistant adapters. Cat. No. 2031.
- 24) At temperatures of over +40 °C and / or when not filled to capacity, bottles may warp during centrifugation.

CERTIFICATIONS / REGISTRATIONS

Product certification:



Product registration:



Company certifications:



DIMENSIONS – ROTANTA 460

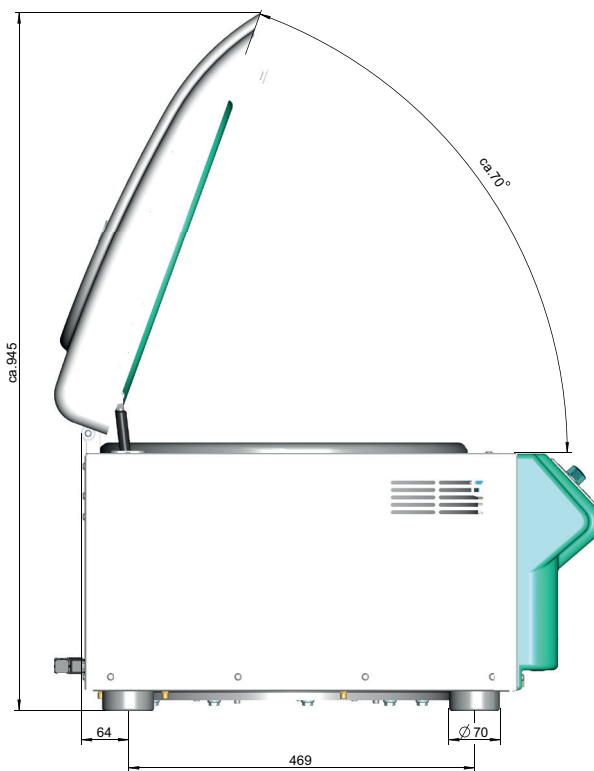
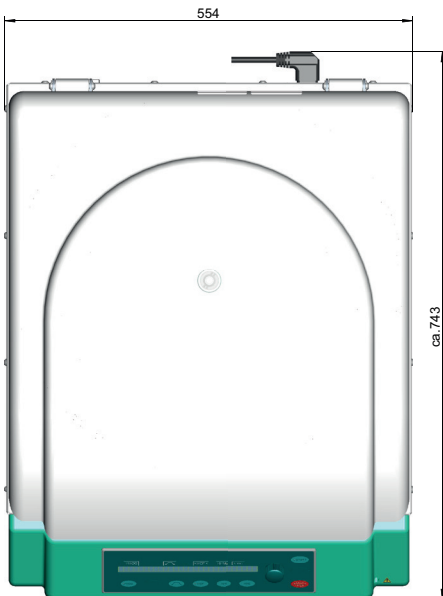

— DIMENSIONS – ROTANTA 460 R

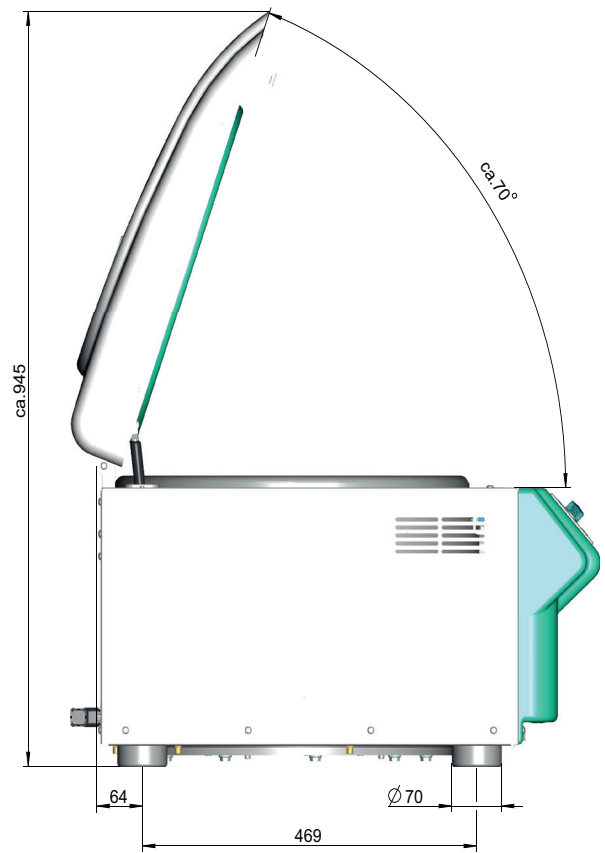
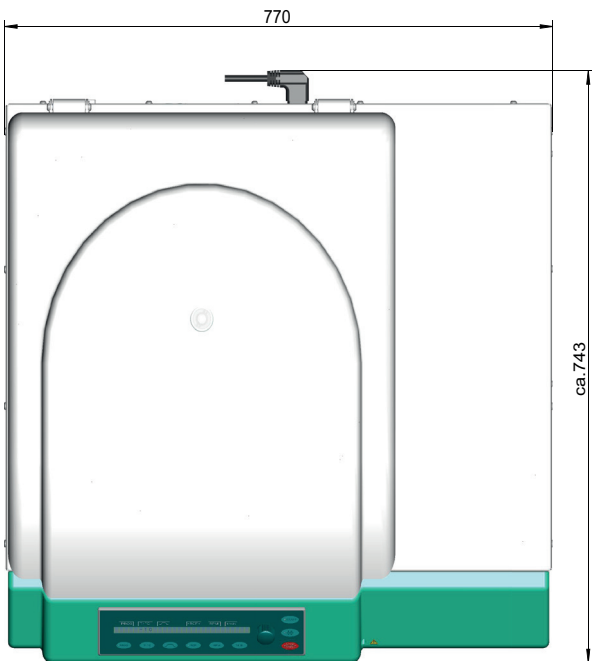
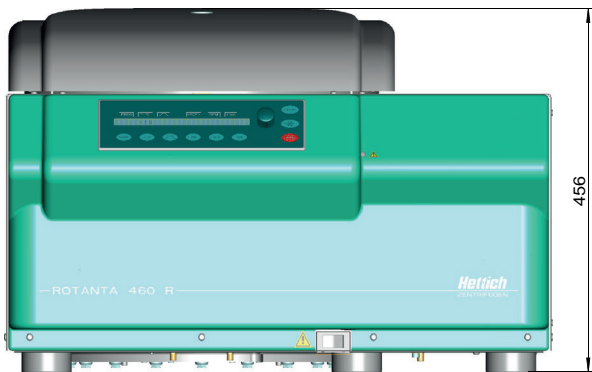



Use the above details to contact us if this literature doesn't answer all your questions.

Pricing on any accessories shown can be found by keying the part number into the search box on our website.

The specifications listed in this brochure are subject to change by the manufacturer and therefore cannot be guaranteed, please provide these to our sales team so that details can be confirmed.

